

016 から CK_CTR
へのルートは最短で

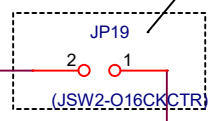

PWB=GN-1585-1 がベース

KEK		
Title SOI-SITCP Sub Board : MALPIX7 LEFT		
Size A4	Document Number FUJITA_MATSUOKA	Rev 1.0
Date: Monday, October 31, 2016	Sheet 1	of 6

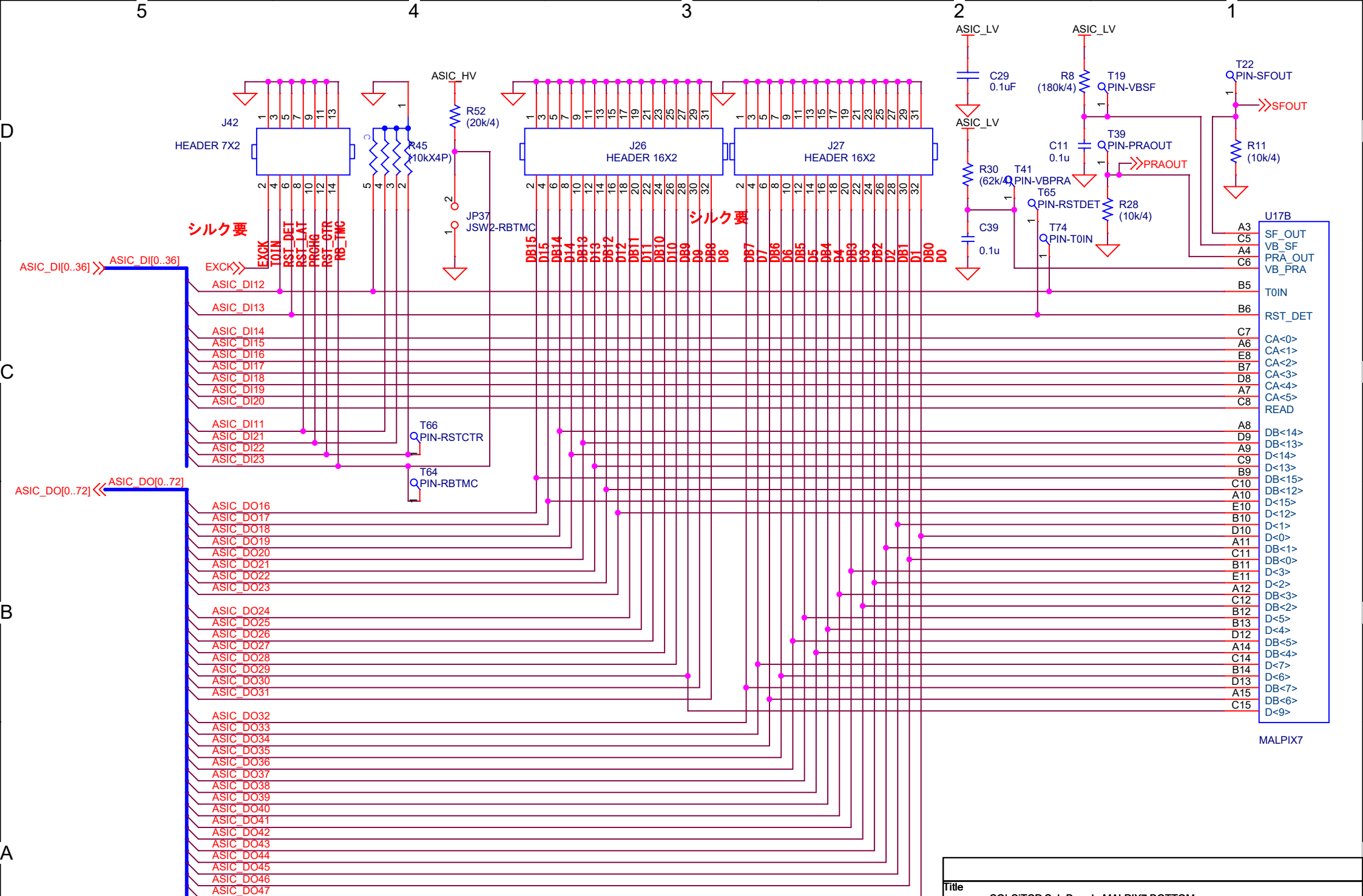

シルク要

シルク選

U17B

MALPIX7

Title		
SOI-SITCP Sub Board : MALPIX7 BOTTOM		
Size	Document Number	Rev
A4	FUJITA_MATSUOKA	1.0
Date:	Monday, October 31, 2016	Sheet 2 of 6

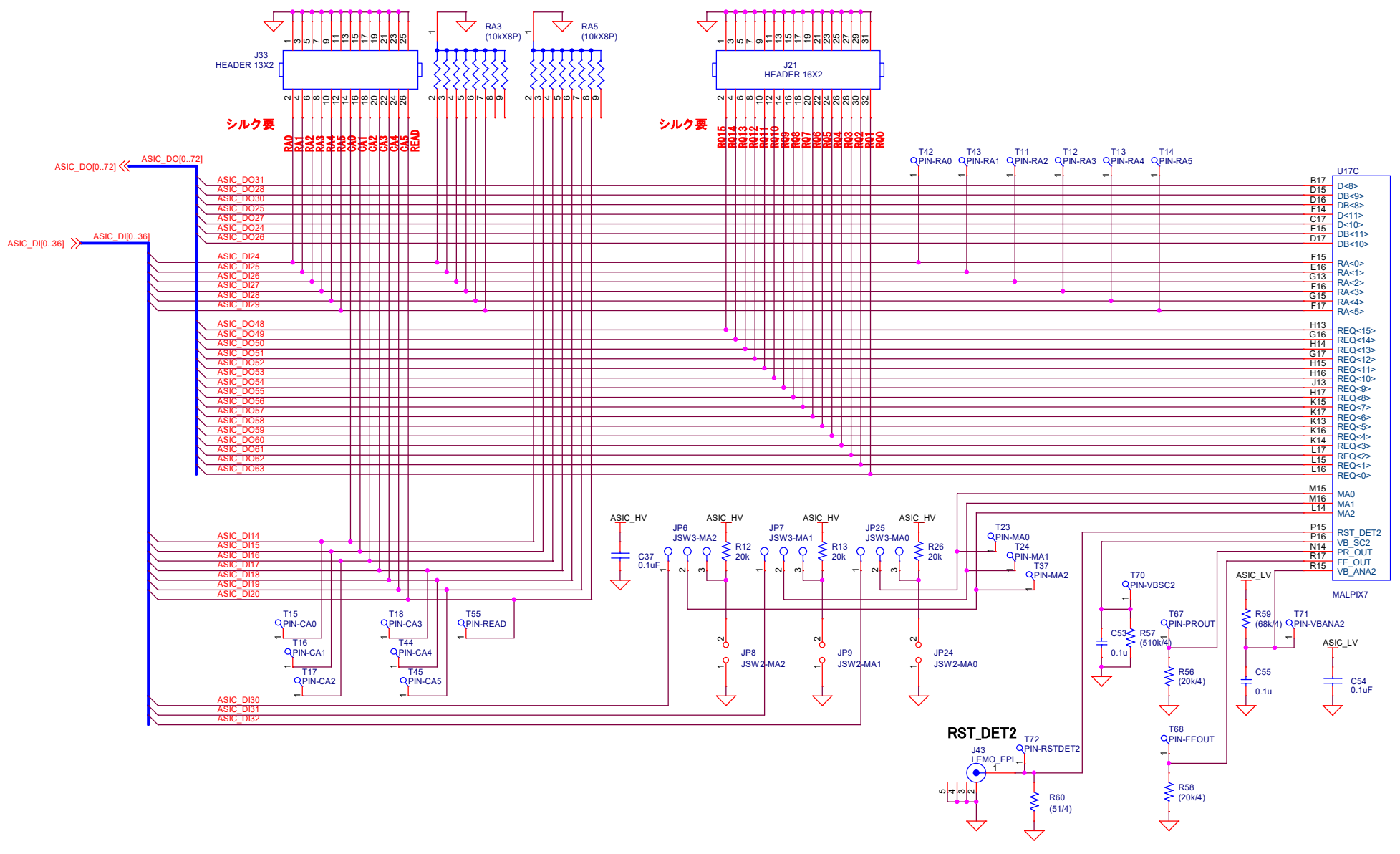

Title		
SOI-SITCP Sub Board : MALPIX7 RIGHT		
Size	Document Number	Rev
A3	FUJITA_MATSUOKA	1.0
Date:	Monday, October 31, 2016	Sheet 3 of 6

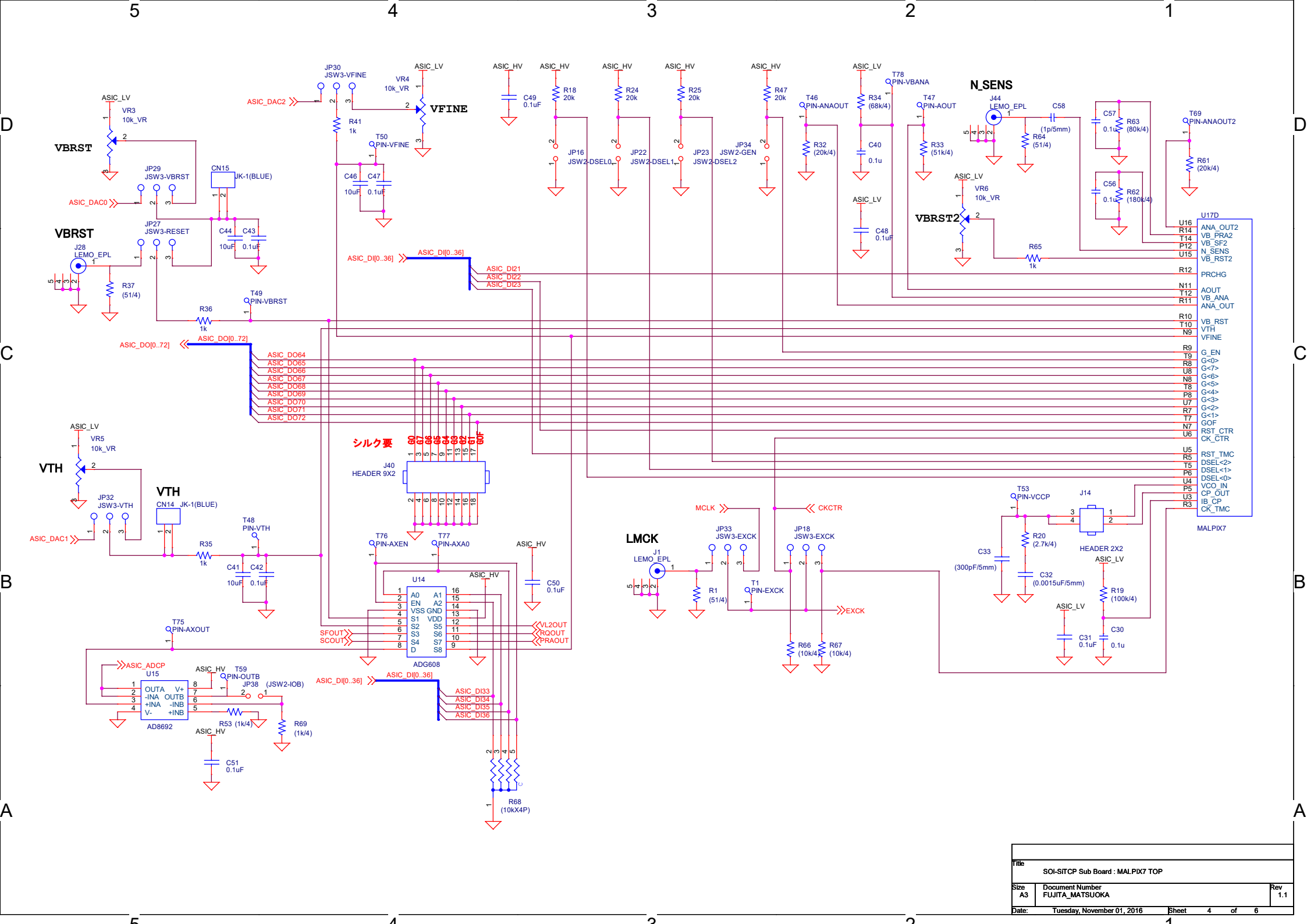

File		
SOI-SITCP Sub Board : MALPIX7 TOP		
Size	Document Number	Rev
A3	FUJITA_MATSUOKA	1.1
Date:	Tuesday, November 01, 2016	Sheet 4 of 6

5

4

3

2

1

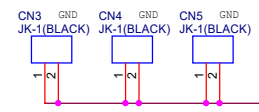
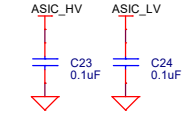
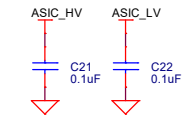
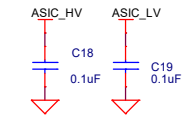
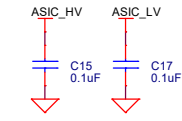
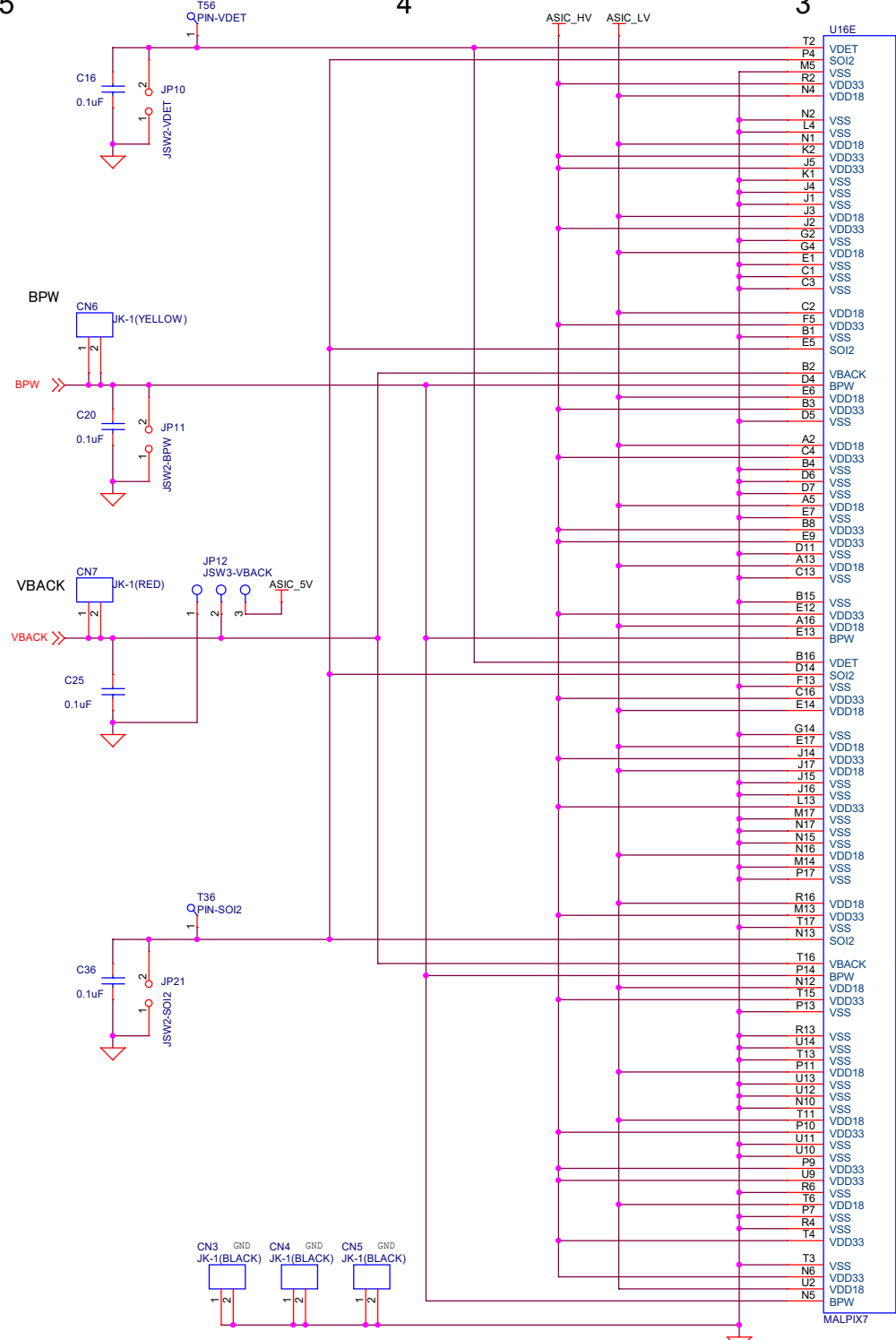

Title			
SOI-SITCP Sub Board : MALPIX7 POWER			
Size	Document Number	Rev	
A3	FUJITA_MATSUOKA	1.0	
Date:	Friday, October 28, 2016	Sheet	5 of 6

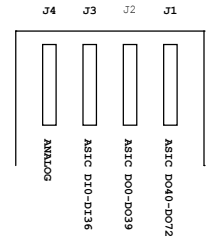
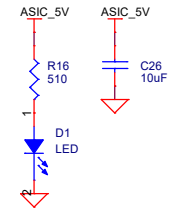
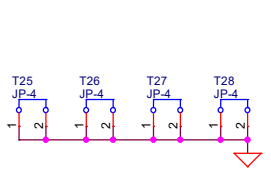
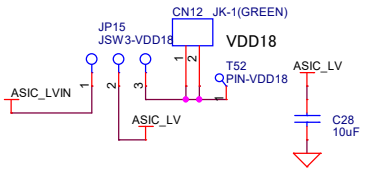
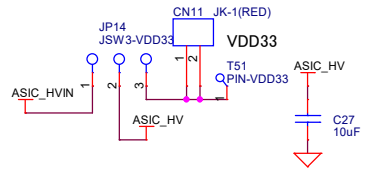
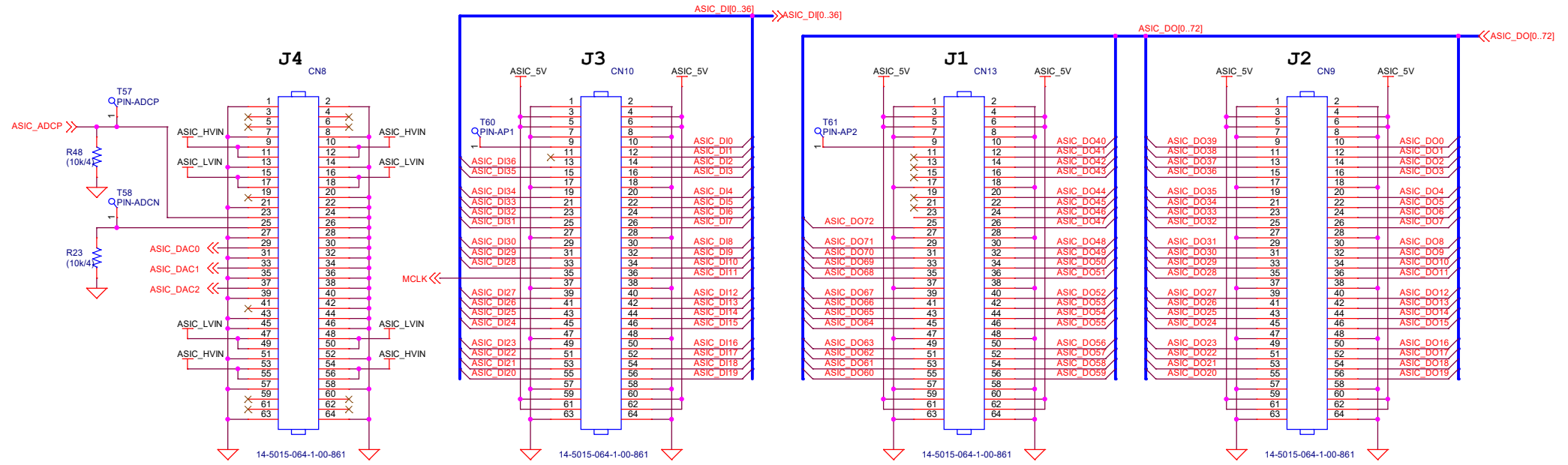

Title			
SOI-SITCP Sub Board : MALPIX7 Connectors			
Size	A3	Document Number	FUJITA_MATSUOKA
Date:	Tuesday, November 01, 2016	Sheet	6 of 6
		Rev	1.1