

GN-1041-1
MADE IN JAPAN

SEABAS Sub Board INTPIX3 V1

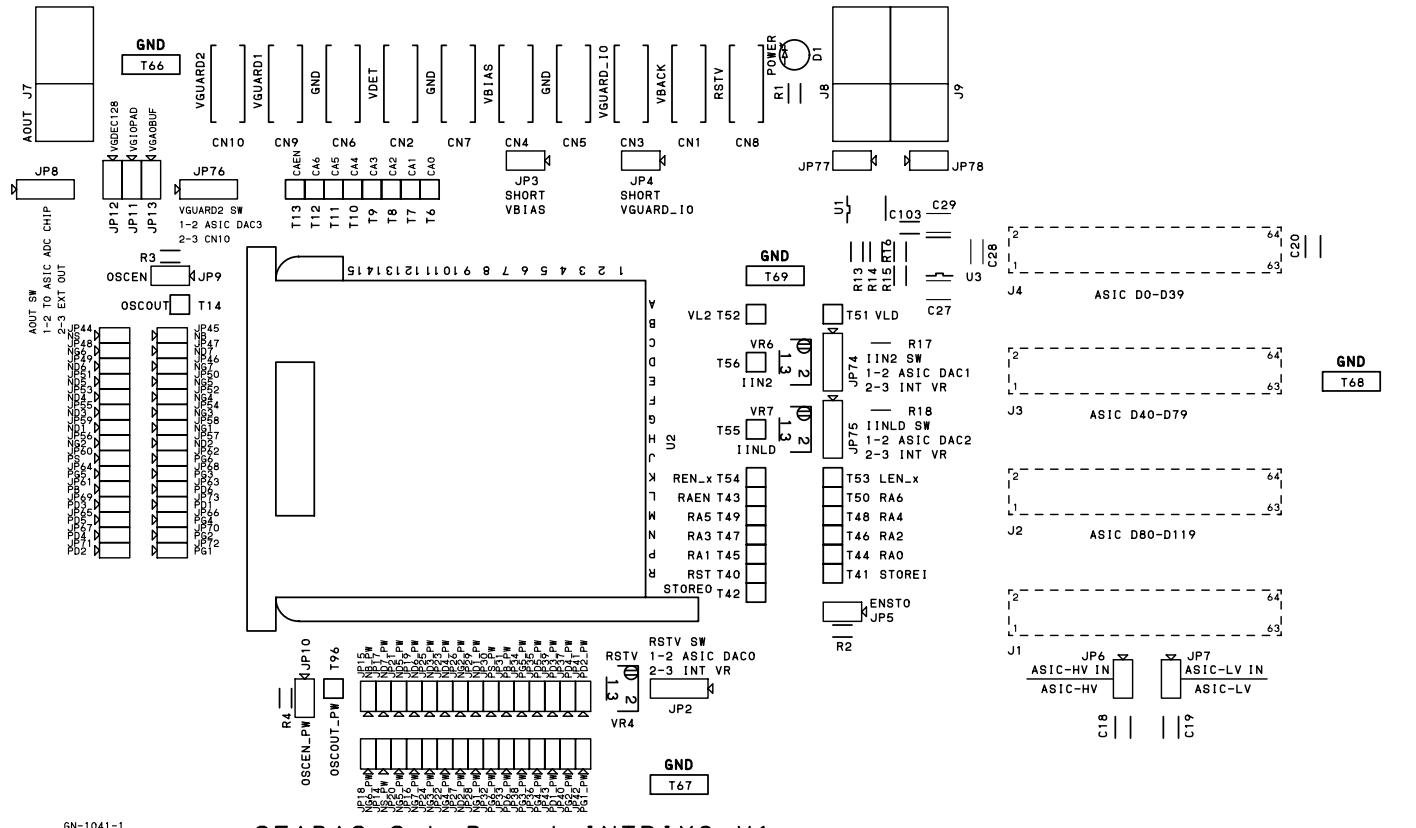

GN-1041-1
MADE IN JAPAN

SEABAS Sub Board INTPIX3 V1

KEK GN-1041-1 10/06

L1 SILK

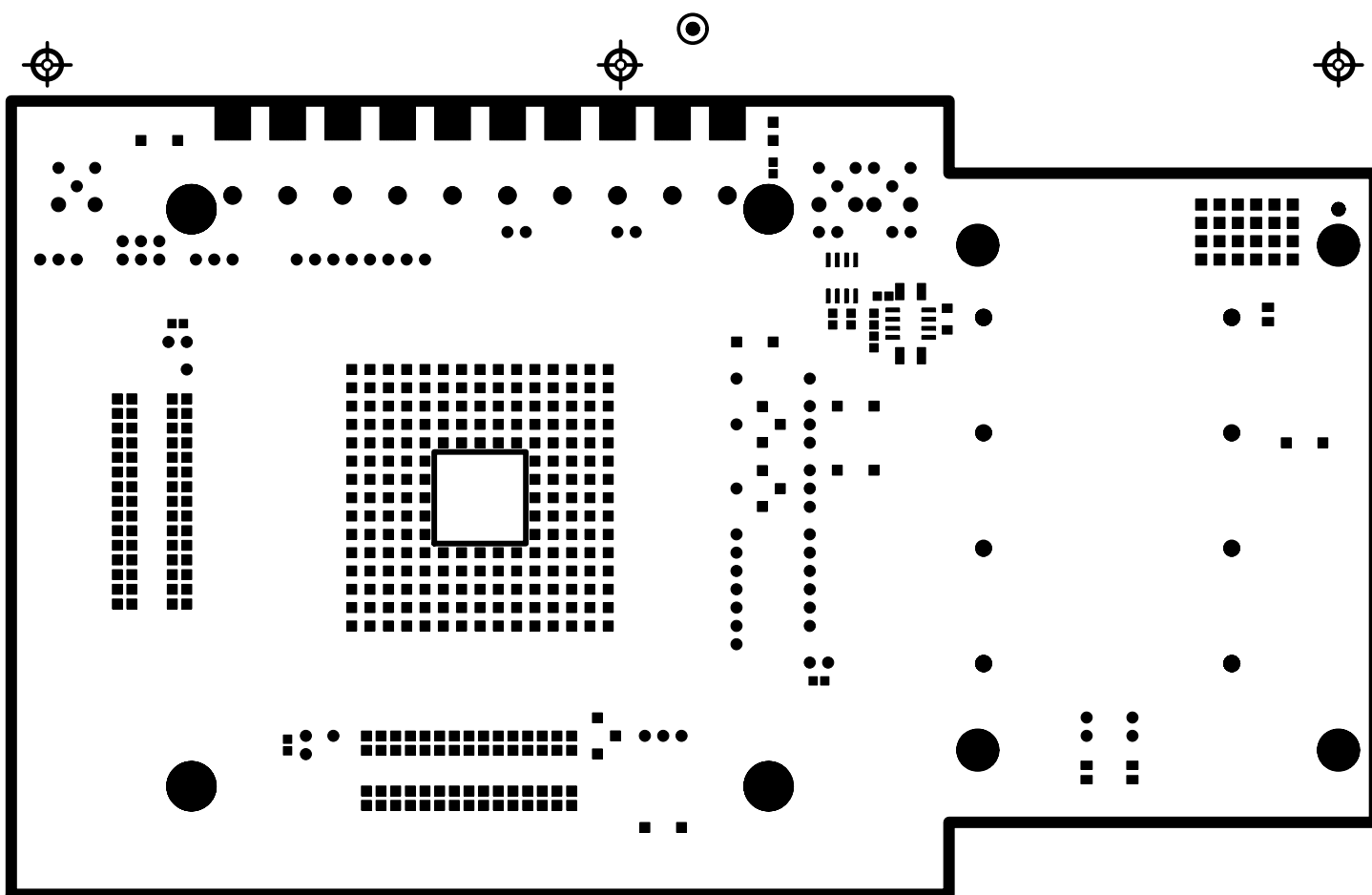

KEK GN-1041-1 10/06

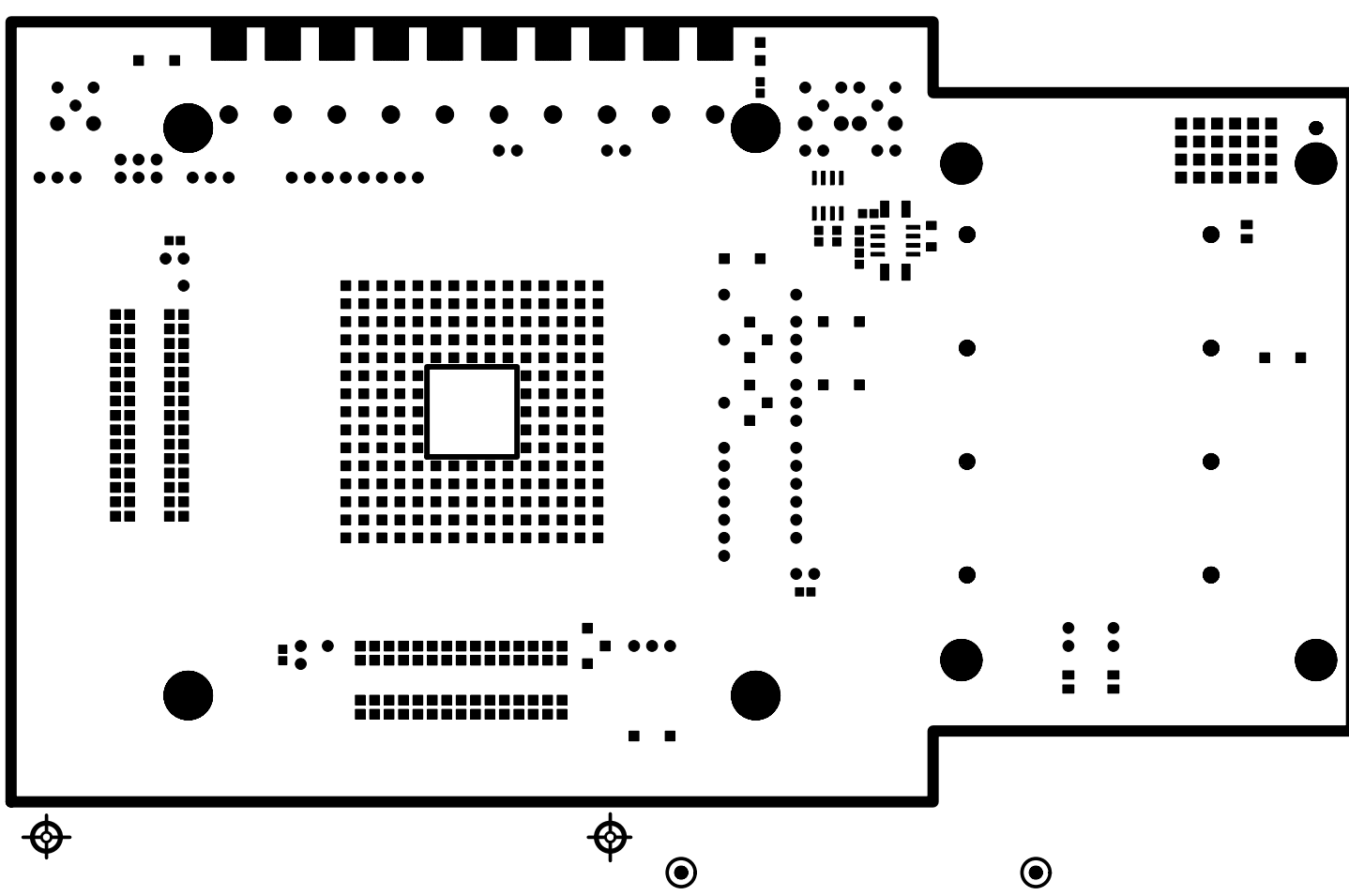

L1 MASK

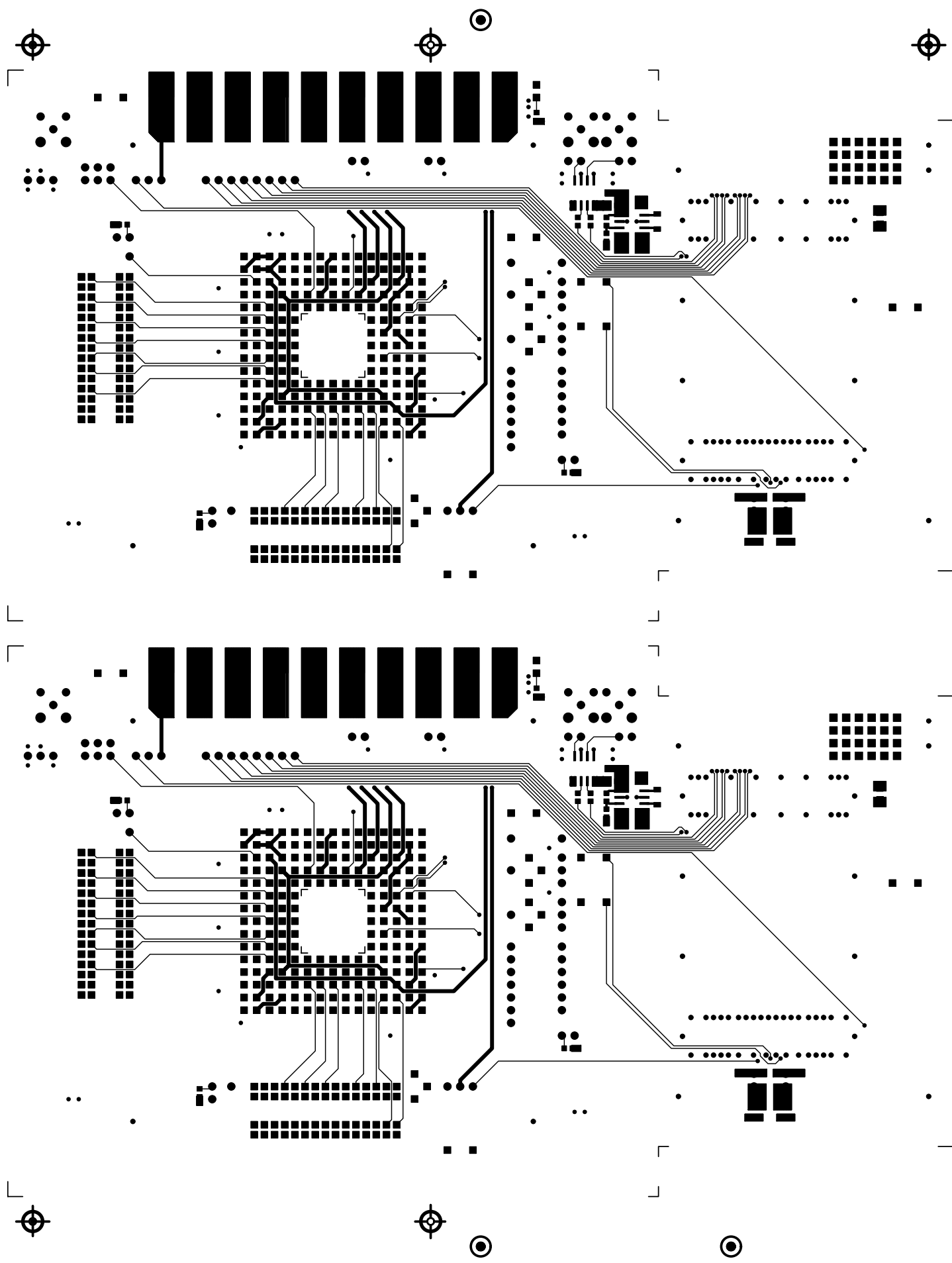

KEK GN-1041-1 10/06

L1

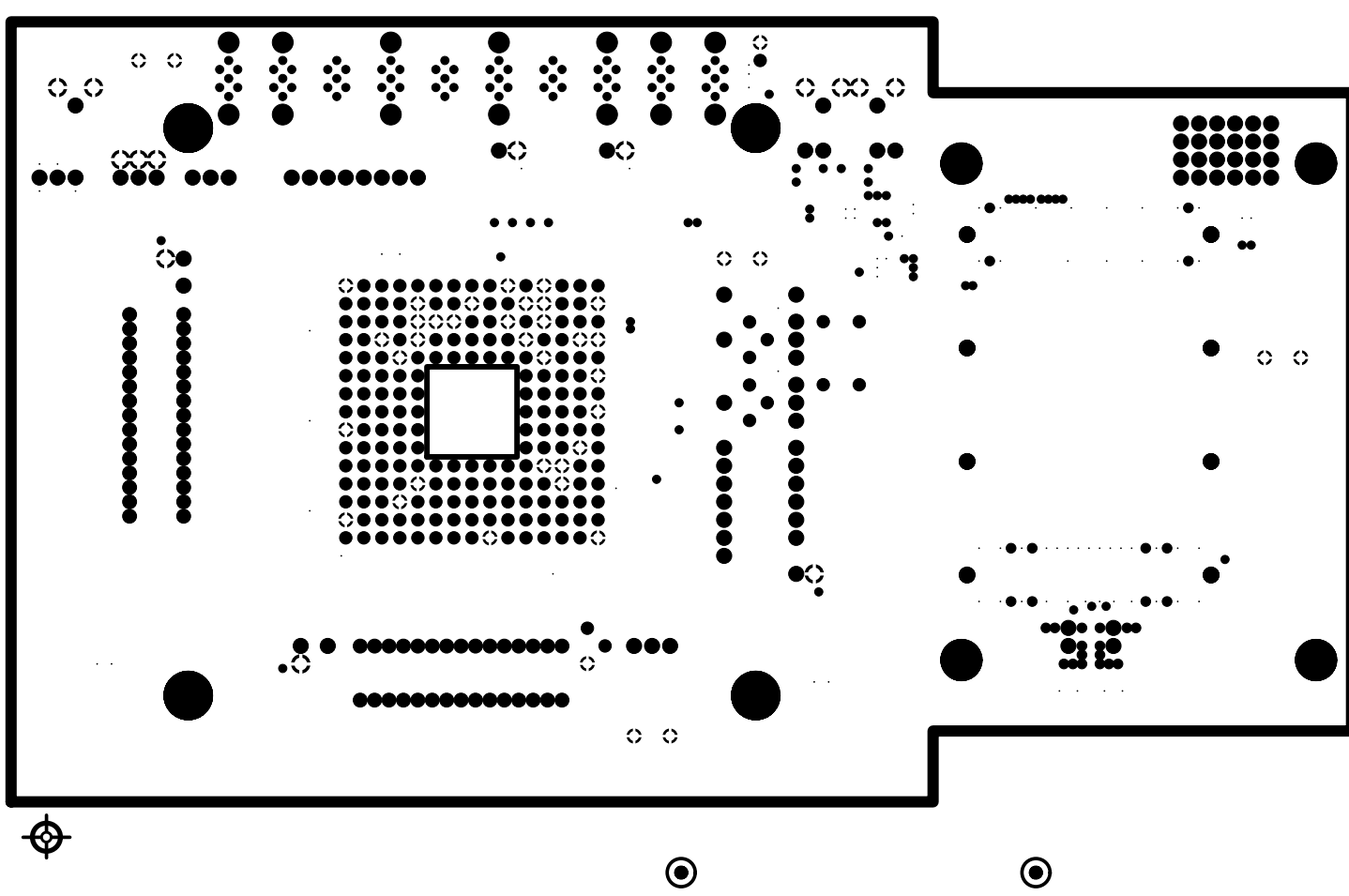
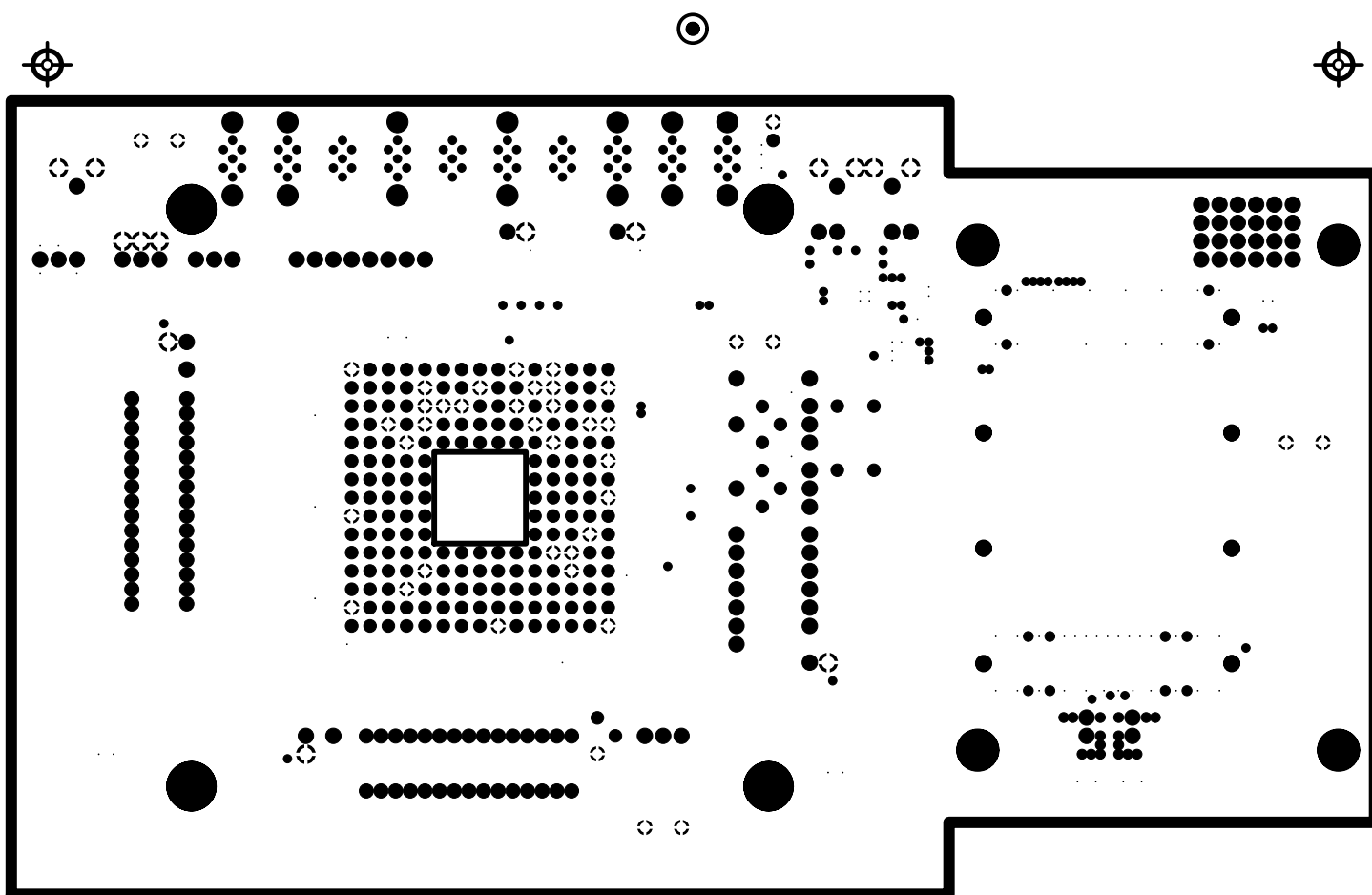

KEK GN-1041-1 10/06

L2

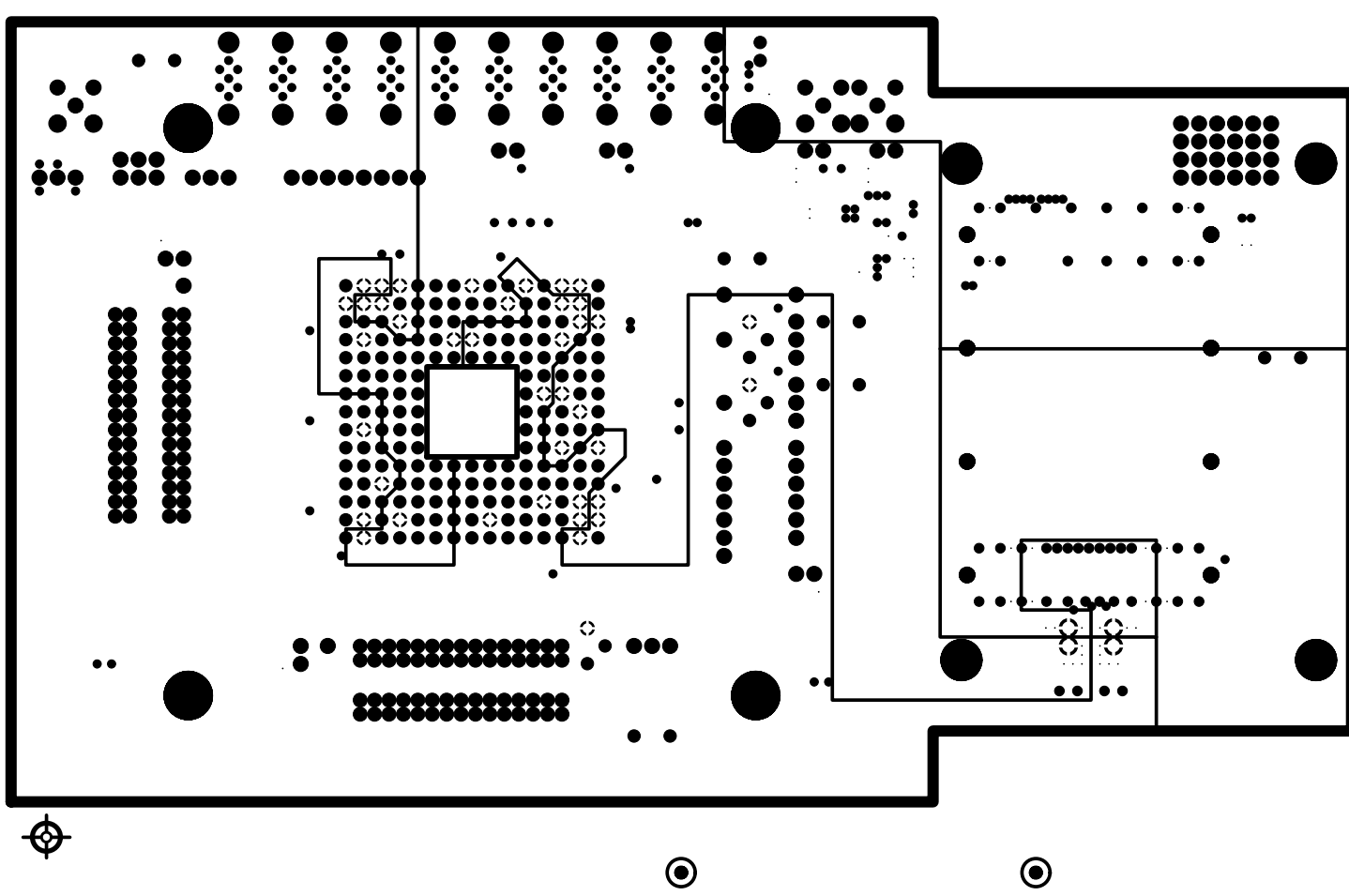
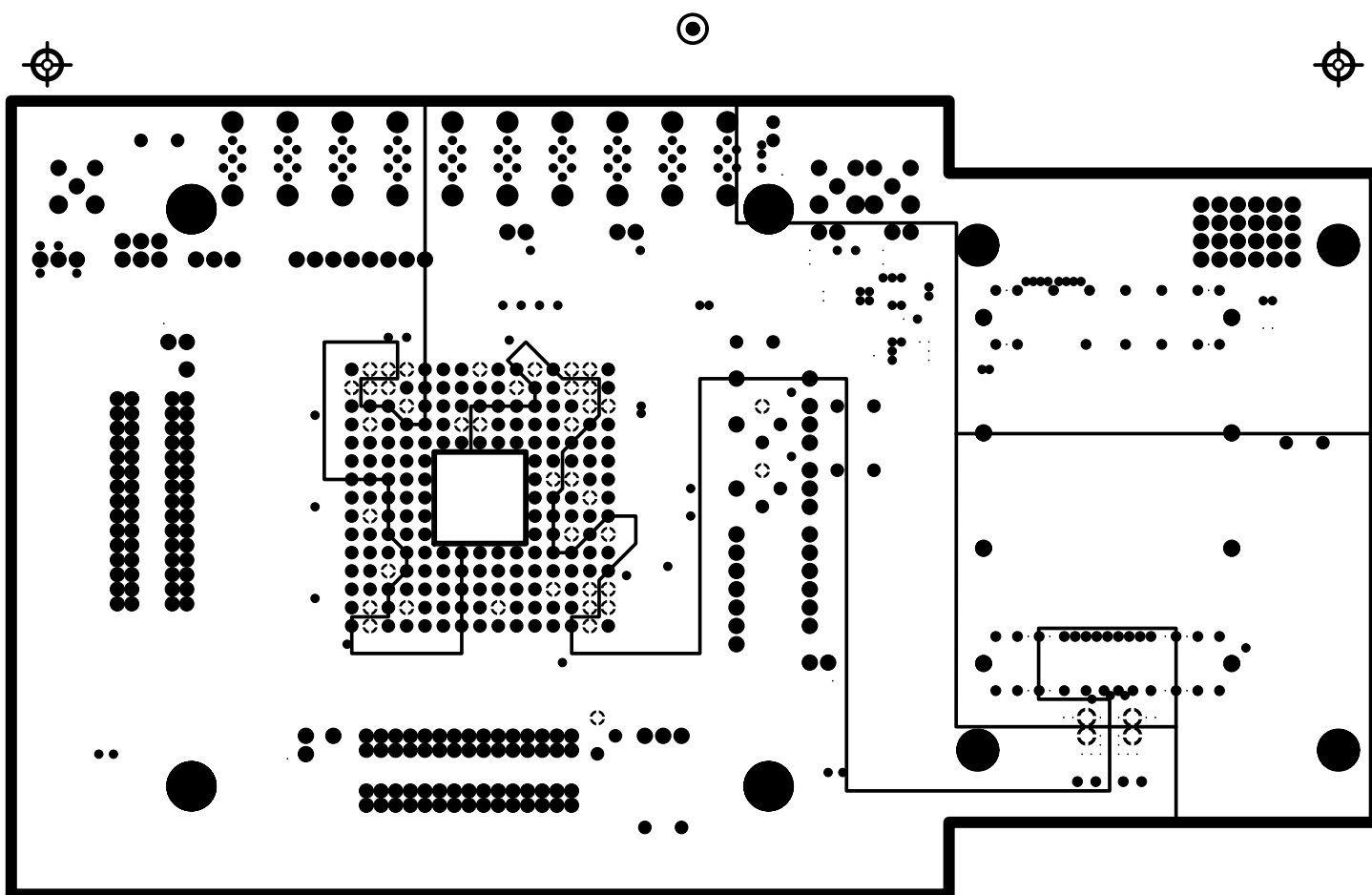

KEK GN-1041-1 10/06

L3

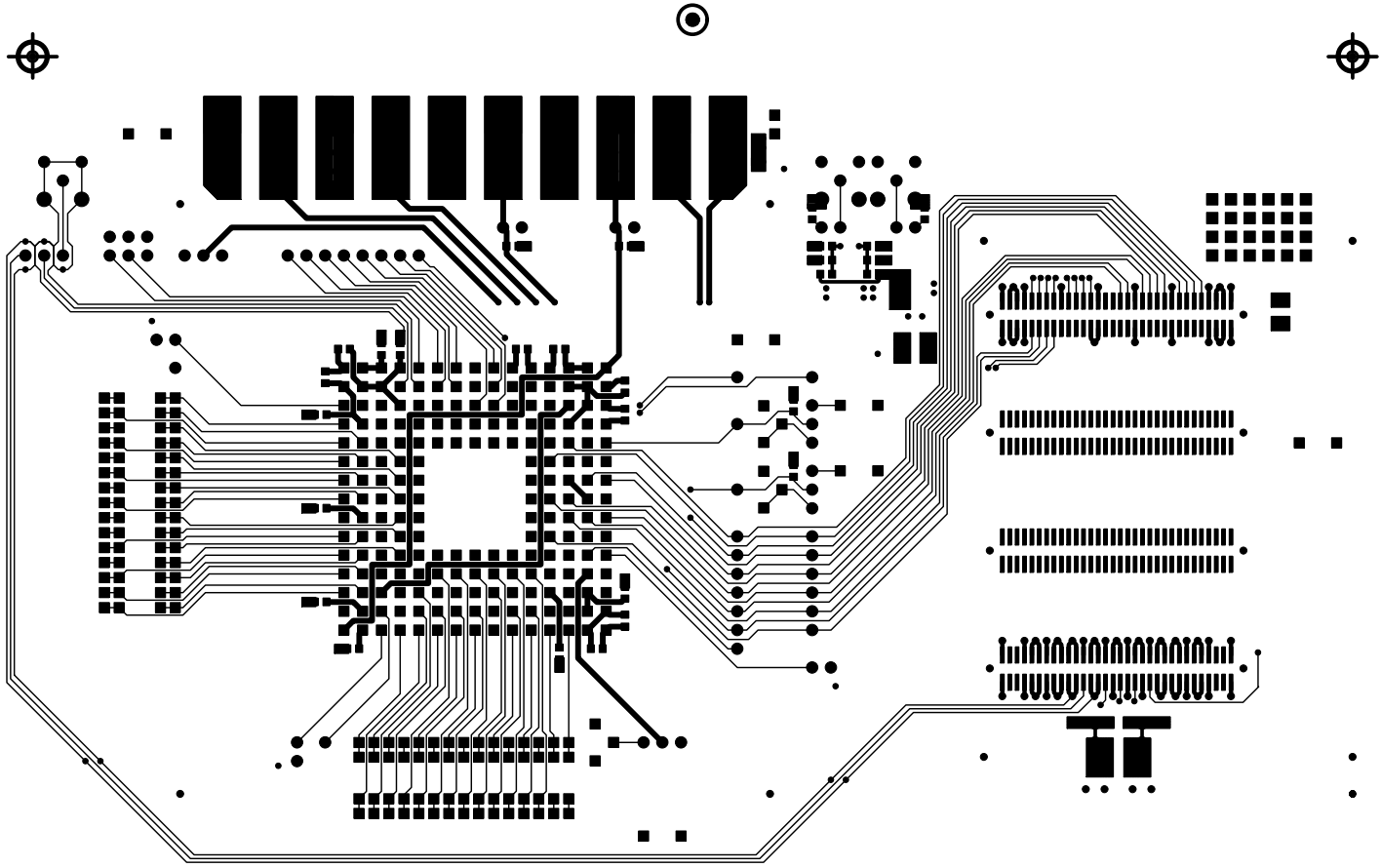

KEK GN-1041-1 10/06

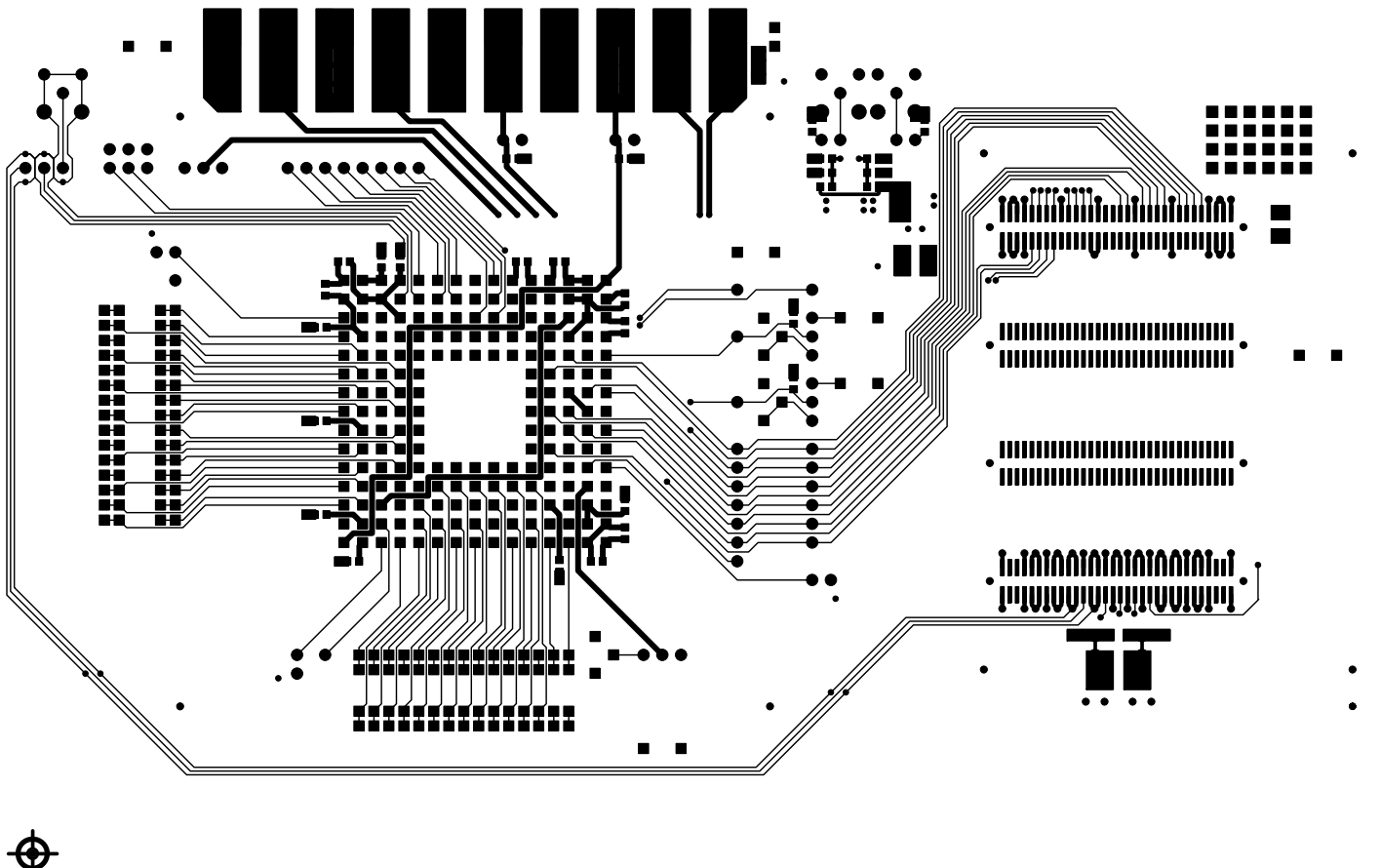

4J

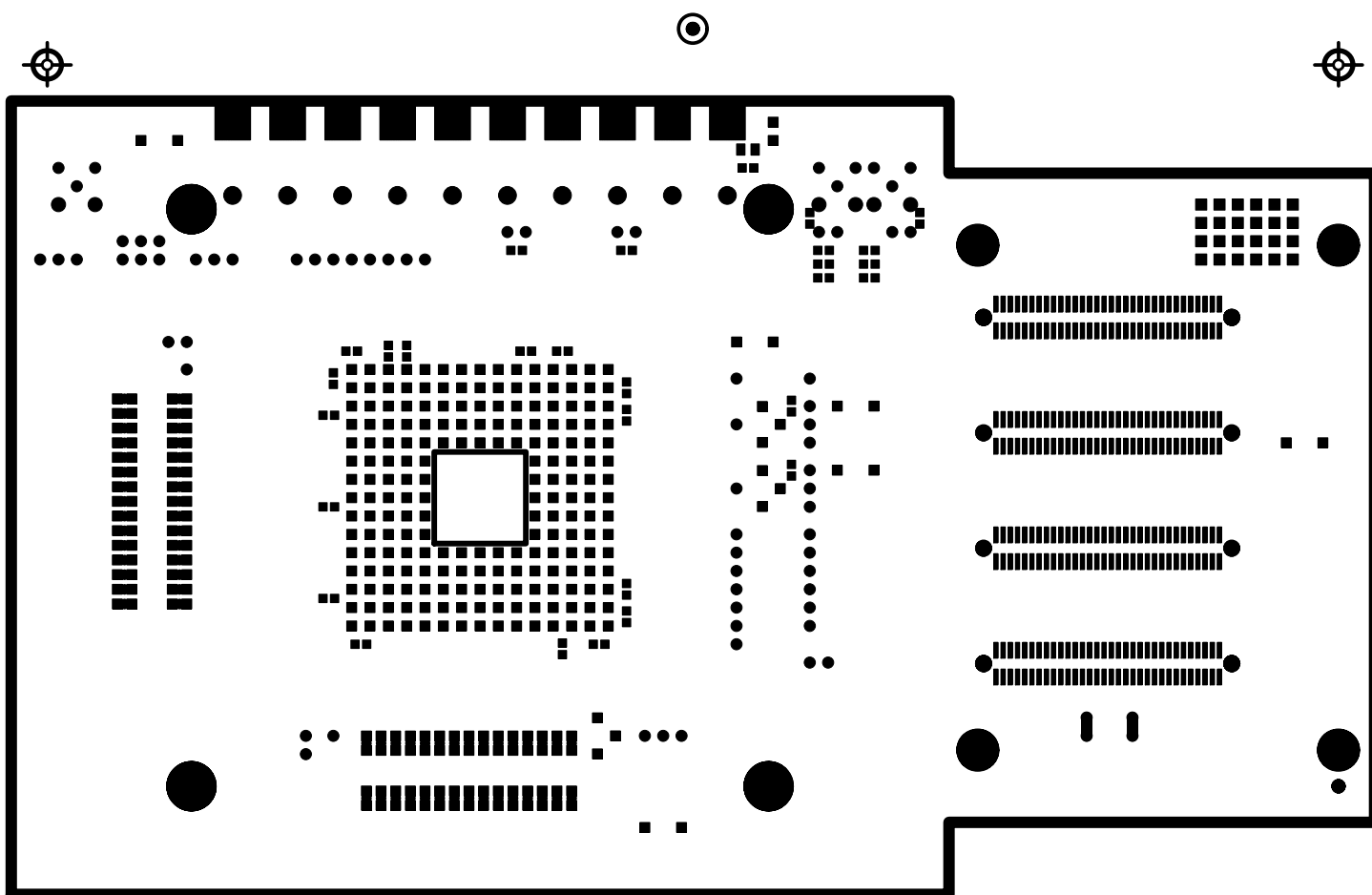

KEK GN-1041-1 10/06

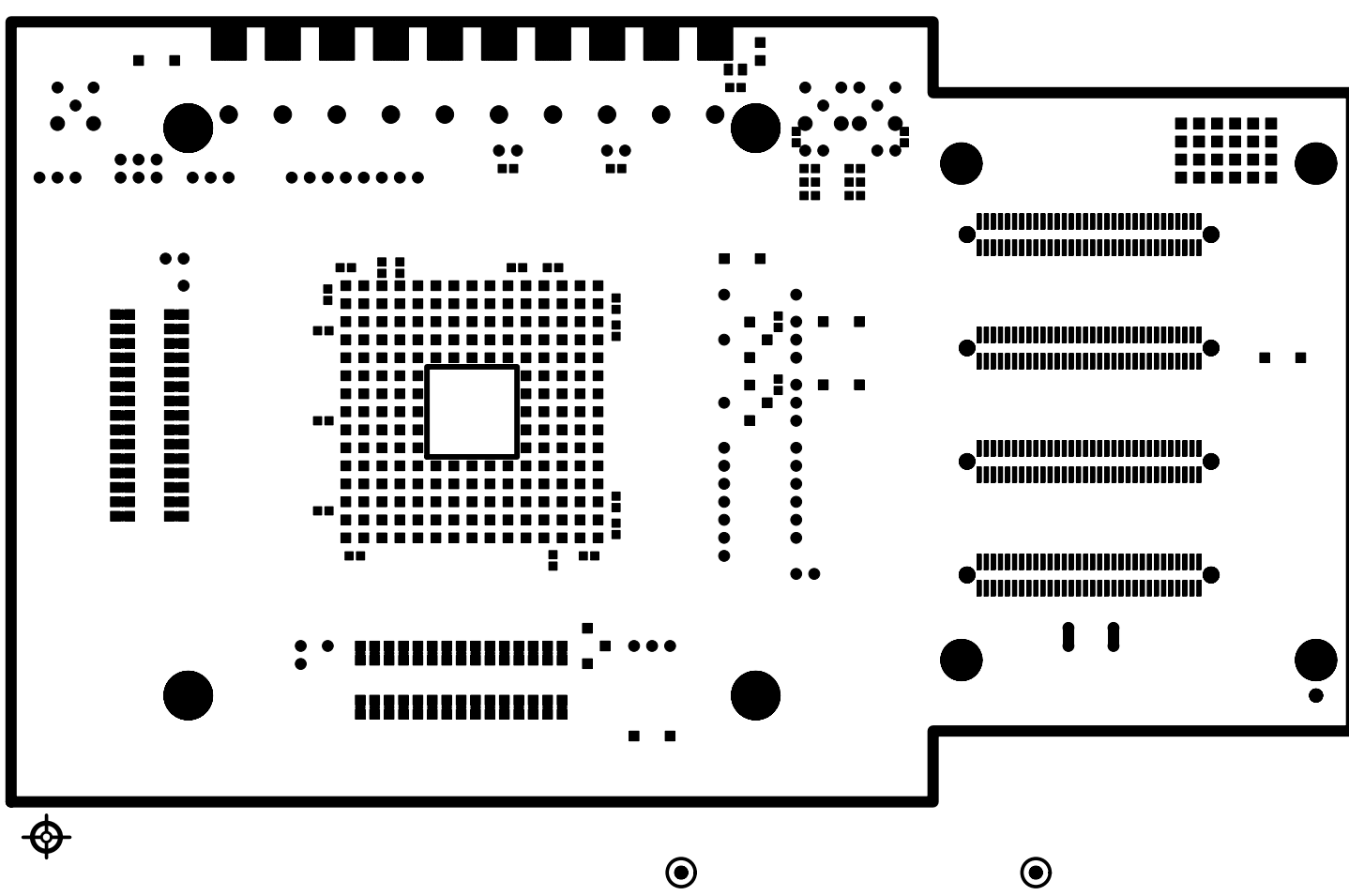

L4 MARK

KEK GN-1041-1 10/06

KLJIS 4J



3 1 3 1 3 1 3 1

3 1 3 1 3 1 3 1

3 1 3 1 3 1 3 1

3 1 3 1 3 1 3 1

R15
R10
R05
R11
R06
R01

R15
R10
R05
R11
R06
R01

C52
C51

C52
C51

C15
C14
C13
C12
C11
C10
C09
C08
C07
C06
C05
C04
C03
C02
C01

C15
C14
C13
C12
C11
C10
C09
C08
C07
C06
C05
C04
C03
C02
C01

